

M12 Y4-coding

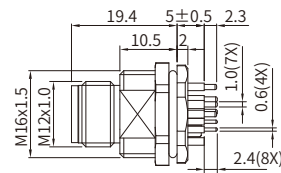

M12 Y4-coding Straight Connector, Panel Mount, PCB, Front fastened, With Earth Pin

Male



Specifications

Contacts	8
Pin layout(Male)	
Standard	IEC 61076-2-113
Ambient temperature	-40°C ~ +80°C(fixed installation) / -20°C ~ +80°C(flexible installation)
Connector insert	TPU+GF
Connector contacts	Brass with gold plated
Coupling nut/screw	Brass with nickel plated
Seal/O-ring	FKM
Insulation resistance	≥100MΩ
Contact resistance	≤10mΩ
Earth tag/pin	Available
IP rating	IP67 in locked condition
Mating endurance	>500 cycles
Rated current	6A(Power Pin), 0.5A(Data Pin)
Rated voltage	50V AC/ DC

Part Number

Pins	Y4
8	MB12MBSY408ST-2

Panel Cut-out Dimensions

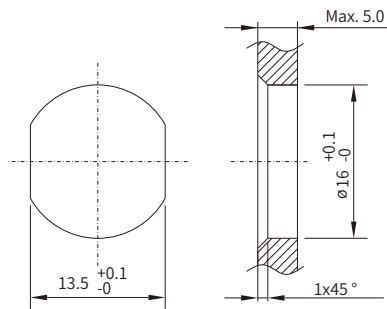

PCB Layout

